

NEW

UV-LED MODULE

LIGHTNINGCURE[®] LC-L2

It's here, the UV light source you've been waiting for!



Why Hamamatsu?

Hamamatsu has built a solid reputation through providing high-quality spot light sources, and now offers a UV-LED module as a "new solution" of UV light sources. This UV-LED module was developed by consolidating all our technologies accumulated over long years. Besides reducing the load on the environment, it will support UV curing and related applications. We are also applying our expertise as an optical device manufacturer to UV light monitoring and control (UV power meter) in order to enhance the possibilities of UV-LED.

- Slim Body
- Long Life
- No Fan
- High Stability, High Output

7500 mW/cm²

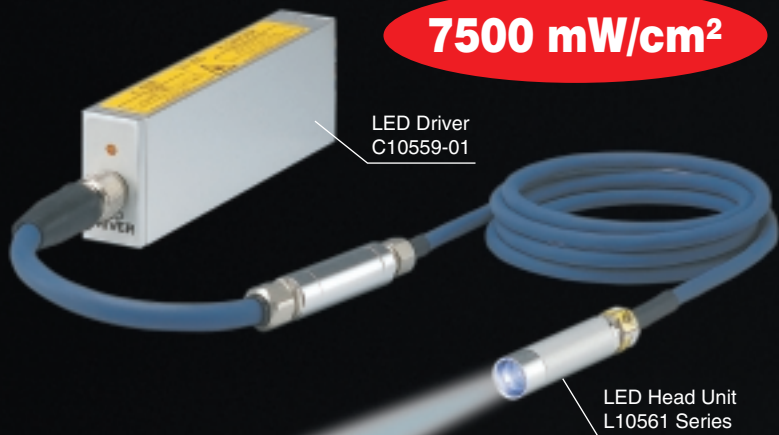

APPLICATIONS

- UV adhesive curing
- UV irradiation experiments

SPECIFICATIONS

Parameter	Description / Value
UV Irradiation Intensity	7500 mW/cm ² ①
Peak Wavelength	365 nm ± 5 nm
Class	3B (JIS C 6802:2005)
LED Life	20 000 hours ②
Input Voltage (DC)	12 V to 24 V
Power Consumption (Max.) ③	8 W
Cooling Method	Air cooling without blower
Operating Temperature Range	+5 °C to +35 °C
Storage Temperature Range	-10 °C to +60 °C
Operating / Storage Humidity Range	Below 80 % (No condensation)
Applicable Standard	EN61326: 1997+A1: 1998 ClassA EN61010-1 2001
Warranty Period ④	1 year

NOTE:

- ① Models with even higher UV intensity are available.
- ② Estimated time when used in a standard environment.
- ③ When operated with L10561 or L10906 series LED head unit.
- ④ This is the period during which UV Irradiation Intensity maintains at least 50 % of the initial value.

Space-saving design reduces the cubic volume by up to 98 %!

No more need to worry about how to reduce the footprint during production or assembly line design. The LC-L2 uses a modular structure containing a drive circuit and therefore allows a freely changeable layout without worrying about space and location. It also uses LED driver harnesses that eliminate the need for extension cables and makes the unit available at a low cost.

This is Hamamatsu at its best!

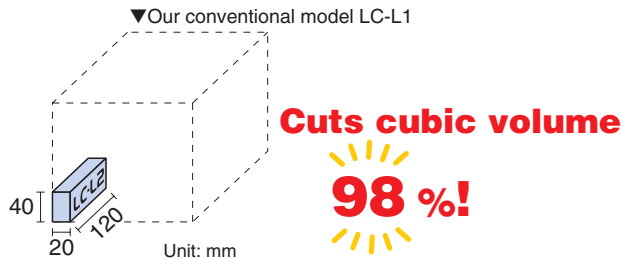

The driver module includes all required functions for external control including manual/auto irradiation, input of UV intensity setting, and output of irradiation-ON signals and error signals. Connecting to a PLC* allows freely controlling the operation.

When used with an optional driver hub unit and control box, multiple units can be easily controlled via various interfaces such as RS-232C or from the operation panel of the control box.

This is Hamamatsu at its best!

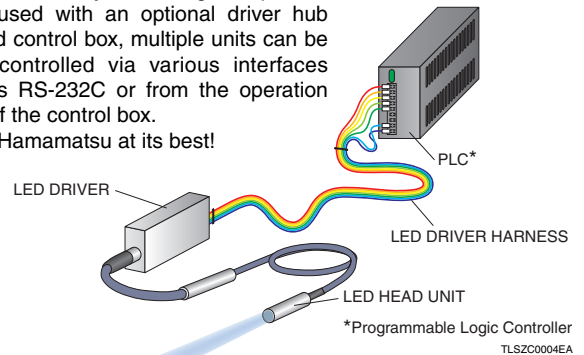

No feedback circuits and temperature sensors required! Super stability and high output whenever needed!

Higher LED temperatures cause the LED light output to drop and also shorten its service life. To suppress a temperature rise, users usually have to rely on measures such as feedback circuits, temperature sensors, mode switching, or custom-designed heads. Also, heads that use ordinary heat-dissipating fins have a poor contact surface area due to the clamping means, so a wide drift appears in the light output. Hamamatsu UV-LED products do not have these problems because our ingenious heat dissipating technology allows you to maintain a stable light output with just a small clamping jig.

This is Hamamatsu at its best!

●Light Output Stability

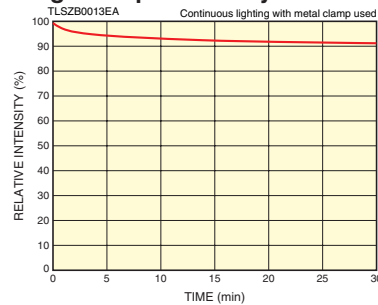

Hamamatsu is a photonic product specialist, so we know how to use photonics technology!

We design an optimal lens to match the job, investigate the principle of light measurement, and then provide the optimal solution. We put all types of photonics technology to work, and probe deep to come up with the answer to customer needs.

This is Hamamatsu at its best!



Minimal thermal effects!

●Temperature on Irradiated Surface

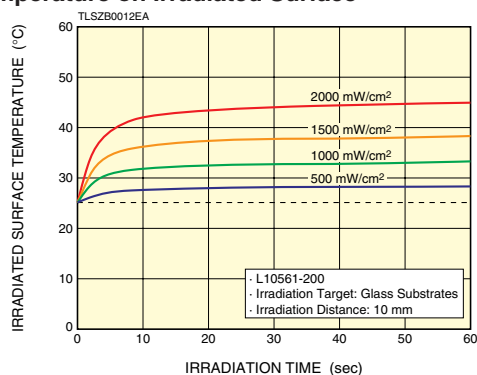

No fan allows confident operation in a clean room.

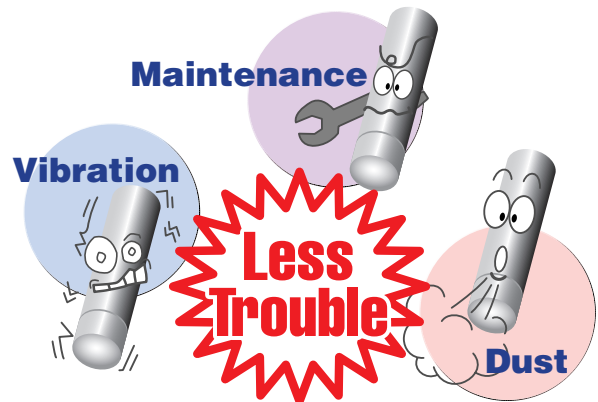

Power-saving – Requires only 8 W.



External control to meet every need.

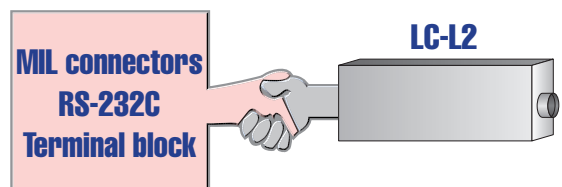

Various types of irradiation patterns.

Hamamatsu condenser lenses are designed to provide the maximum light collection efficiency at each focal distance so that high UV irradiation intensity can be obtained.

Z: Distance from output end of lens

— Z=10 mm — Z=15 mm — Z=20 mm — Z=25 mm — Z=30 mm — Z=35 mm — Z=40 mm

●L10561-200 Illuminated area $\phi 12$ mm

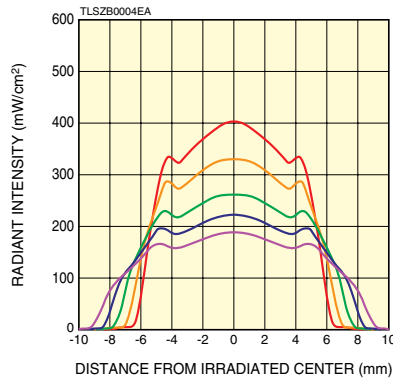
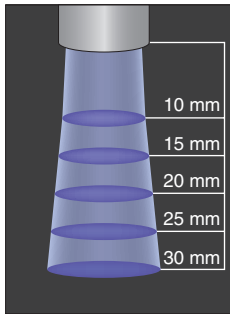

●L10561-210 Illuminated area $\phi 3$ mm

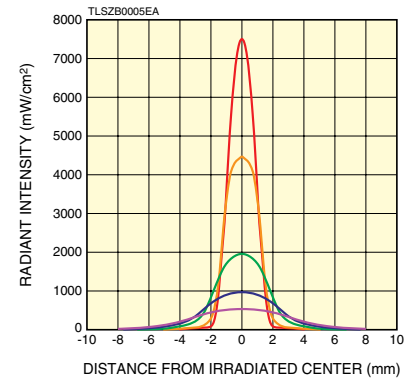
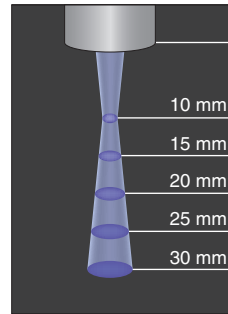

●L10561-215 Illuminated area $\phi 6$ mm

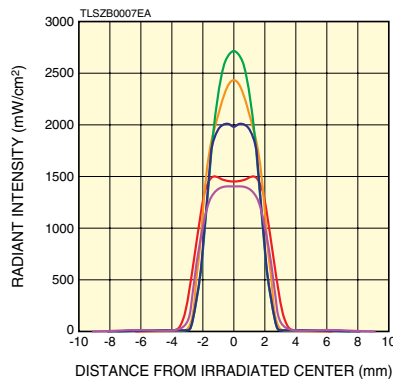
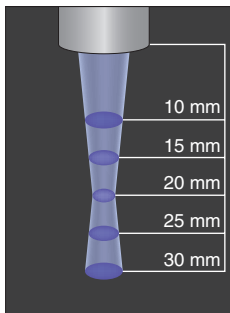

●L10561-220 Illuminated area $\phi 8$ mm

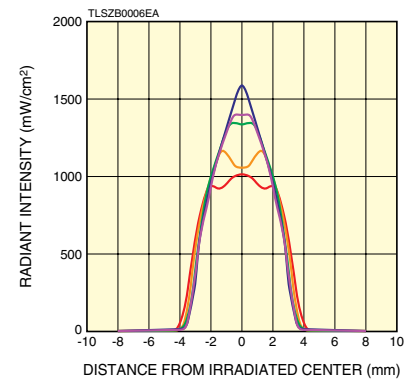
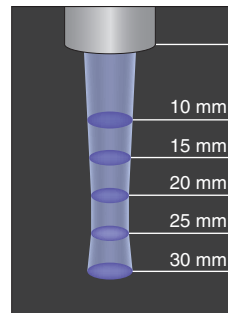

The newly developed collimate type always maintains high irradiation intensity without depending on the irradiation distance, so it does not require high positioning accuracy of clamping jigs and contributes to production stability.

The linear beam type produces a long, oval lighting pattern that covers a wide irradiation area, making it ideal for applications where different shapes of workpieces or multiple points should be cured by one irradiation.

We also design custom lenses to meet your needs.

●Collimate type L10906-101

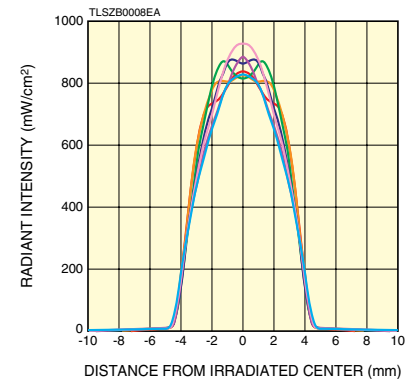
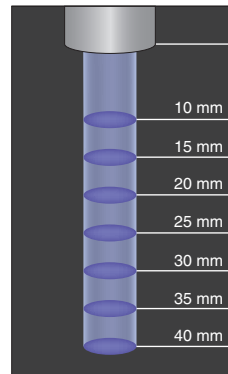

●Linear beam type L10906-102

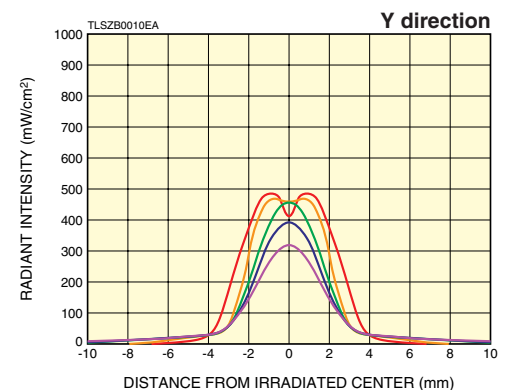
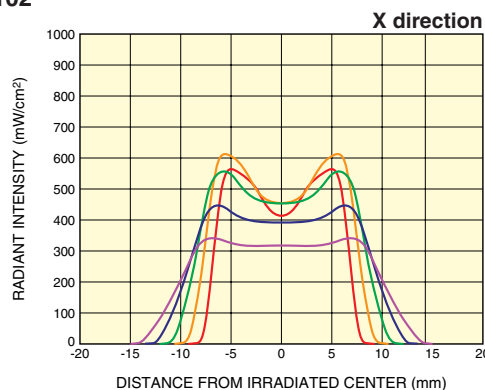
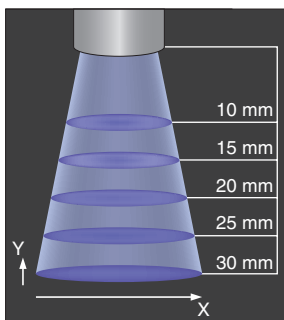

Simple setup! Up to 8 units can be operated with dedicated controller and driver hub.

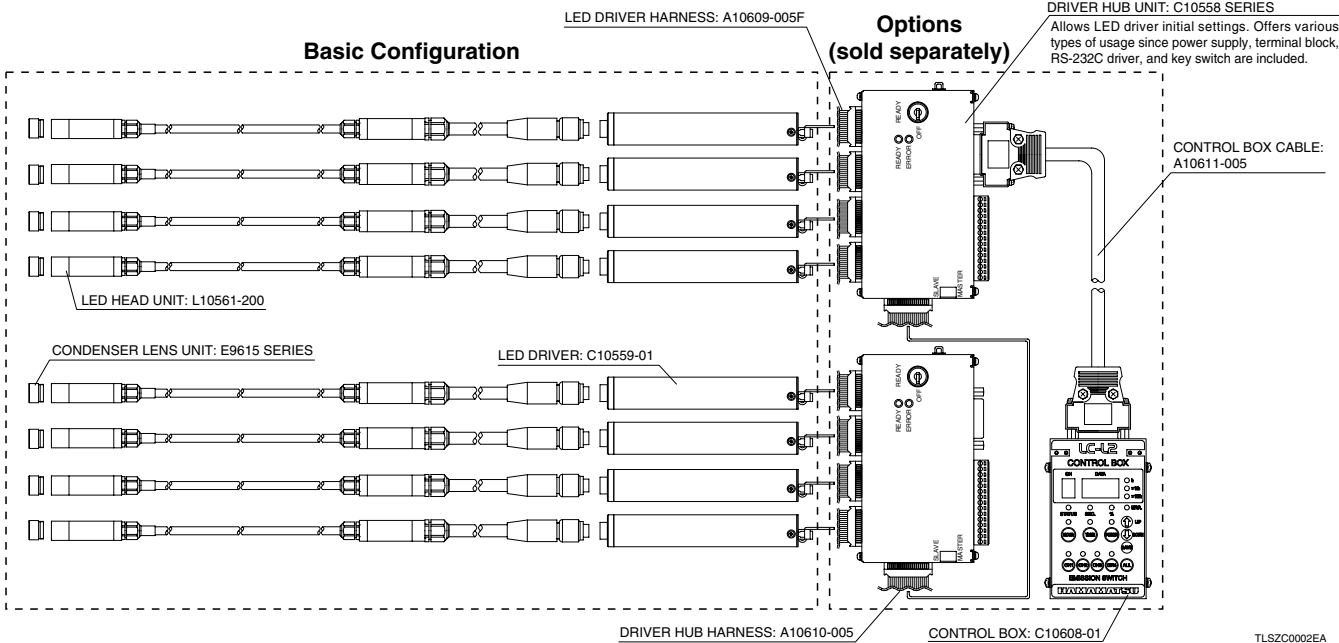

DIMENSIONAL OUTLINES (Unit: mm)

●LED Driver C10559-01

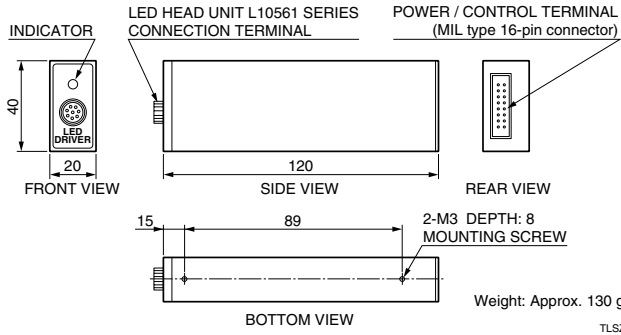

●Condenser Lens E9615 Series* (Option)

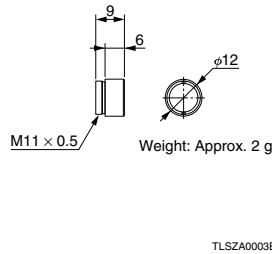

Type No.	Illuminated Area (mm)	Lens Holder Color
E9615-010	φ3	Silver
E9615-015	φ6	Blue
E9615-020	φ8	Black

* Custom-made condenser lenses are available upon request.

●LED Head Unit L10561 / L10906 Series*

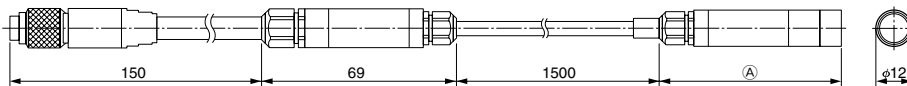

Type No.	Illuminated Area (mm)	Lens	Dimension ^(A) (mm)	Weight (g)
L10561-200	φ12	Not included	55	Approx. 102
L10561-210	φ3	Included	61	Approx. 104
L10561-215	φ6	Included	61	Approx. 104
L10561-220	φ8	Included	61	Approx. 104
L10906-101	φ9	Not included	61	Approx. 104
L10906-102	20 x 6	Not included	51	Approx. 102

* Custom-made condenser lenses are available upon request.

CLAMP

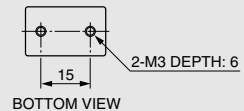
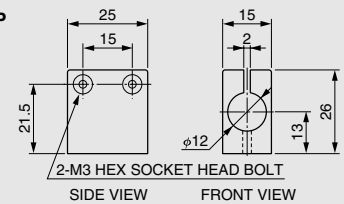

Always use this clamp to enhance heat dissipation.

TLSZA0002EA

Subject to local technical requirements and regulations, availability of products included in this promotional material may vary. Please consult with our sales office. Information furnished by HAMAMATSU is believed to be reliable. However, no responsibility is assumed for possible inaccuracies or omissions. Specifications are subject to change without notice. No patent rights are granted to any of the circuits described herein. ©2008 Hamamatsu Photonics K.K.

HAMAMATSU

WEB SITE www.hamamatsu.com

HAMAMATSU PHOTONICS K.K., Electron Tube Division

314-5, Shimokanzo, Iwata City, Shizuoka Pref., 438-0193, Japan, Telephone: (81)539/62-5248, Fax: (81)539/62-2205

U.S.A.: Hamamatsu Corporation: 360 Foothill Road, P. O. Box 6910, Bridgewater, N.J. 08807-0910, U.S.A., Telephone: (1)908-231-0960, Fax: (1)908-231-1218 E-mail: usa@hamamatsu.com

Germany: Hamamatsu Photonics Deutschland GmbH: Arzbergerstr. 10, D-82211 Hersching am Ammersee, Germany, Telephone: (49)8152-375-0, Fax: (49)8152-2658 E-mail: info@hamamatsu.de

France: Hamamatsu Photonics France S.A.R.L.: 19, Rue du Saule Trapu, Parc du Moulin de Massy, 91882 Massy Cedex, France, Telephone: (33)1 69 53 71 00, Fax: (33)1 69 53 71 10 E-mail: infos@hamamatsu.fr

United Kingdom: Hamamatsu Photonics UK Limited: 2 Howard Court, 10 Tewin Road Welwyn Garden City Hertfordshire AL7 1BW, United Kingdom, Telephone: 44-(0)1707-294888, Fax: 44-(0)1707-325777 E-mail: info@hamamatsu.co.uk

North Europe: Hamamatsu Photonics Norden AB: Smidesvägen 12, SE-171-41 SOLNA, Sweden, Telephone: (46)8-509-031-00, Fax: (46)8-509-031-01 E-mail: info@hamamatsu.se

Italy: Hamamatsu Photonics Italia: S.R.L.: Strada della Moia, 1/E, 20020 Arese, (Milano), Italy, Telephone: (39)02-935 81 733, Fax: (39)02-935 81 741 E-mail: info@hamamatsu.it

TLSZ1002E02
AUG. 2008 IP